

# ATHLETICS OMNIBUS - DISCUS THROW

From the Athletics Omnibus of Richard Stander, South Africa

## DISCUS THROW

Discus Throw is regarded as a strength event. The Discus Thrower is required to throw a saucer shaped implement called a discus as far as possible. Depending on the age and gender of the athlete the weight of the implement will vary between 1kg and 2kg.

### 1. THE COMPETITION AREA

**IMPLEMENT** - The body of the Discus is made of wood or other suitable material, with a metal rim, the edge of which forms a true circle. Each side of the Discus must be identical and it must be made without indentations, projections or sharp edges. The diameter is 219mm for men and 180 to 182mm for women.

**THROWING CIRCLE** - The inside diameter of the circle measures 2,50m. It is made of iron, steel or other suitable material and the top of it must be flush with the ground outside. The surface of the interior of the circle must be level and 20mm lower than the upper edge of the rim of the circle. The inside of the circle is made of concrete, asphalt or some other firm but not slippery material.

**THE DISCUS THROWING CAGE:** The discus circle is surrounded by a cage to ensure the safety of officials, participants and spectators. On the ground it is shaped like a letter C, with the diameter of its curved part being 7m and an opening of 6m, through which the throw is carried out. The height of the cage should be at least 3.35m

**THROWING SECTOR:** The throwing sector is limited by the inner edges of lines from an angle of 40° at the centre of the circle.

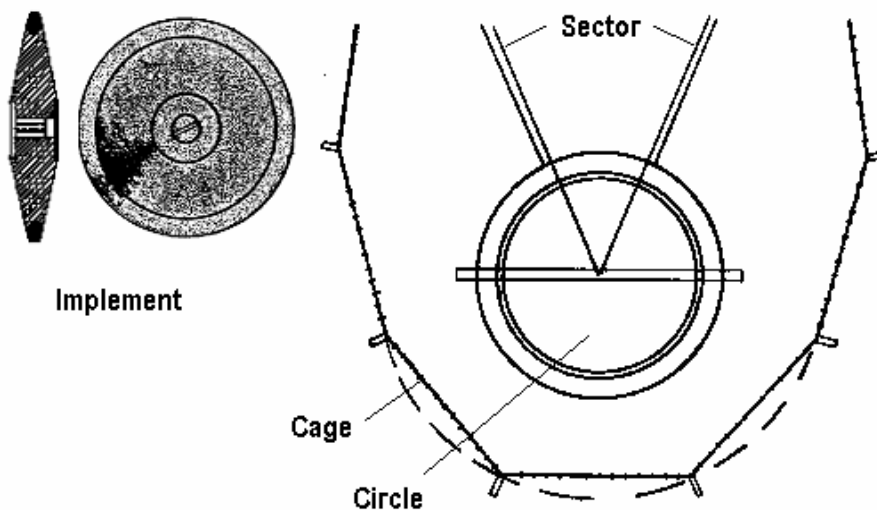

### 2. THE 1½ TURN TECHNIQUE

There is only one basic discus throw technique with individual variations within the technique, but the aim is always to deliver the discus with optimum speed and balance. The right-handed technique will be explained in all examples used in this book. The discus technique comprises of three phases: Swings turn and throw.

- A right-hand thrower performs 1½ turns to the left.
- The left leg is in front when the discus is thrown.

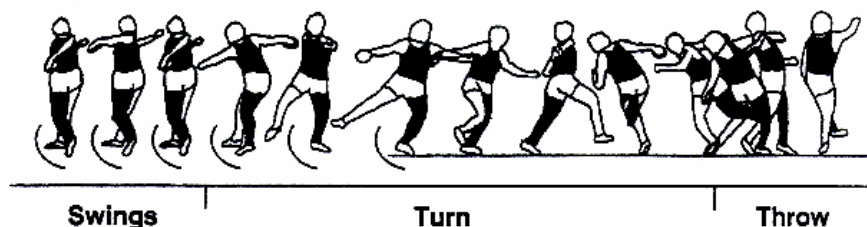

#### 2.1. THE DISCUS THROWER SHOULD AVOID:

- 2.1.1. Falling backwards at the beginning of the turn.
- 2.1.2. Rotating on the spot (like a spinning top).
- 2.1.3. Bending the trunk forward (breaking at the hips).
- 2.1.4. Jumping high in the air.
- 2.1.5. Over tension in the legs.

- 2.1.6. A faulty foot placement in relation to the throwing line.
- 2.1.7. Carrying the body weight on the front leg and allowing it to collapse.
- 2.1.8. Anticipating the throw with the arm. This may include breaking at the hips and bending the trunk forwards or over balancing to the left).

## 2.2. THE DISCUS THROWER SHOULD AIM TO:

- 2.2.1. Get a good pivot.
- 2.2.2. Drive across the circle.
- 2.2.3. Get a good amount of torsion between the lower body and upper body.
- 2.2.4. Cover a good distance in the flight across the circle.
- 2.2.5. Land high up on the toes of the right foot and rotate actively on it.
- 2.2.6. Land with the right foot in the centre of the circle and the left one a little to the left of the throwing line.
- 2.2.7. When both feet are on the ground have the centre of gravity between both legs and resist with the front leg.
- 2.2.8. Time the arm pull with the moment that the shoulders are aligned with the hips.

## 2.3. THE GRIP

The grip determines the position of the discus in flight. Held incorrectly, will lead to a poor flight, no matter how efficient the technique.

- Hold the discus only with the end finger joints (1) so that the finger pads are turned over the rim.
- The fingers should be comfortably and evenly spaced, as relaxed as possible.
- The discus rests against the base of the throwing hand (2).
- The hand will flex slightly inwards at the wrist, but the athlete must not pinch the discus with the wrist (2).
- The thumb rests on the discus (3) to give stability on release. It must not be lifted.
- The discus leaves the hand at the pointing finger turning clockwise.

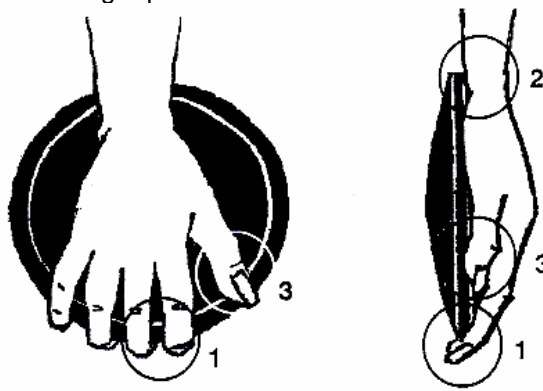

## 2.4. THE SWING

- The athlete takes up position at the back of the ring with the toes almost touching it.
- Swing the discus as far behind to the right as possible, rotating the trunk at the same time (1).
- Do not force the hand to far back otherwise the centre of gravity will be outside the body stance, causing it to be off balance.
- The legs are in a straddle position, shoulder-width apart and the back is in the direction of the throw. Both knees are bending slightly (2).
- The right foot is flat on the ground, pointing in the opposite direction of the throw, and the left foot is on its toe. The weight is balanced over the right heel.
- The head is kept upright throughout the entire movement. Focus on the horizon to keep it upright.

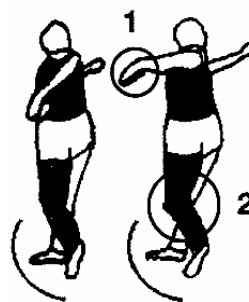

## 2.5. PRELIMINARY SWINGS

- Preliminary swings can be taken to help the body relax and to feel the rhythm.
- The body-weight is being transferred rhythmically from the right foot to the left and back.
- The left knee must not bend too much towards the right knee.
- The right arm travel from back to front and back.
- Do not force the hand too far back to avoid a loss of balance.

## 2.6. THE TURN

- Push of forwards with the left leg, in a running action, in the direction of the throw when the left foot and face is pointing towards the direction of the throw (1).
- Keep the throwing arm as high as possible above hip height and behind the body (2).
- The free arm is in a relaxed position in front of the chest in line with the right arm behind the chest.
- The right leg is swung forward in a rotational motion, almost stretched, and close to the ground.
- The right foot is placed in the centre of the circle and the body weight is now supported by the right leg (3). The left leg takes the shortest possible route around the right leg to the front to develop the rotational speed of the delivery arm.
- Place left leg quickly and actively just in front of the edge of the circle (4) to land in the power position.
- The right knee is in front of the foot and the leg is leading the body. When the shoulders are facing the delivery area, the leverage of the right leg is shortened to enable it to be brought forward faster.
- The left foot must land very soon after the right foot. A late left foot will always result in a loss of range.
- The left arm is bent to facilitate the faster rotation.

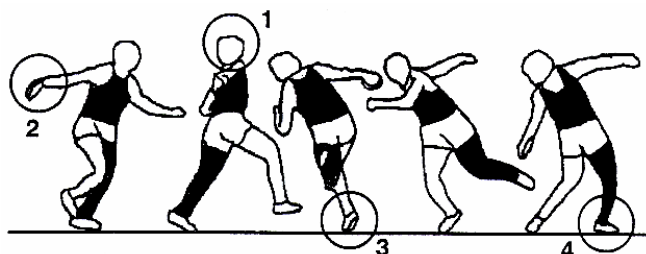
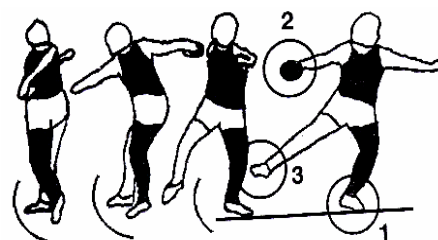

## 2.7. THE POWER POSITION

- The weight is supported on the right leg in the throwing position.
- The right foot is in the centre of the circle and the left foot slightly off centre, to allow for room for the hips to drive through. (The right toe is in line with the left heel)
- The body is in the chin-knee-toe position leaning away from the direction of throw.
- The right heel must never touch the ground until the throw is completed.
- The hips are still leading the shoulders and the trunk is in a torque position.
- The throwing arm is dragging behind the body.
- The left arm is slightly bent.
- The eyes are looking away from the direction of throw.

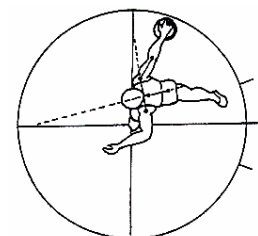
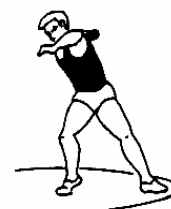

## 2.8. THE THROW

- Only when both feet are on the ground, the throwing action can begin.
- From the power position the thrower should rotate on the ball of both feet.
- Turn the right foot in the direction of the throw. The foot will cause the knee to turn the hip to turn; the shoulder to turn and eventually the throwing arm to come through fast and relaxed.
- When the right hip turns towards the front (1), the right leg must be extended simultaneously.
- With the front foot now firmly grounded, extend the front leg (2) to gain maximum height, and bring the discus through at shoulder height. Keep the front foot on the ground as long as possible. As long as the front foot is on the ground, the right side will continue driving forward. Therefore it is important to time the extension of the front leg correctly.
- The shoulders must be kept level throughout the throw, especially during the final action. This can be achieved by maintaining the chin-knee-toe position. Keep the trunk upright.
- The left arm is dragging behind to delay the rotation of the shoulders, and then remain firm (blocked) during the final thrust of the right side of the body. It must not be allowed to sweep too far backwards.
- Finally the left leg is swung backwards and the feet interchange in order to maintain balance within the circle. Bend the right leg to lower the centre of gravity. The shorter the body, the easier it will regain balance.

- Given the correct sequence of movements, the reverse will automatically take care of itself and on no account should a reverse be conscientiously practised.

## 2.9. DELIVERY ANGLE

Once the discus technique is mastered, the delivery angle needs attention. The discus is highly affected by the wind's speed and direction. A head wind gives the longest throws. The best release angles are:

Angle	Wind direction
+/- 27°	head wind
+ /- 43°	tail wind
36 – 40°	no wind

## 2.10. EXERCISES TO IMPROVE THE TECHNIQUE

### ROLL ACTION

To learn how to hold the discus, and how the discus should leave the hand, stand with the left foot forward, legs slightly bent and the trunk leaning forwards a little. Swing the throwing arm back to front and roll the discus along the ground in a straight line. Keep the throwing arm straight.



### DISCUS SPIN

To learn how to spin the discus when it leaves the hand, take the same position as for the previous exercise but now let the discus spin in the air for a while before it lands on its edge on the ground and then rolls forward.



### FINAL THROW

To practice the final phase of the throw, mark a throwing line on the ground, and stand with the feet astride, with the sole of the right foot on the line and the left foot slightly to the left of the line. Support the discus with the left hand in front of the chest, with the right hand on top of the discus. Swing the discus back with a straight arm, pivoting on the feet. Then rotate forward quickly and throw with extension of the legs but keeping the right foot on the ground.



### CENTRE CIRCLE THROW

To simulate the arrival at the centre of the circle and movements into the throw, use the same actions as in the previous exercise, but now the left leg is lifted from the ground as the trunk rotates to the rear, and then placed down to the ground again as the trunk is turned to the front for the throw.



### FLIGHT EXERCISE

To combine the flight across the circle with the final phase (initial rotation excluded), stand with the left foot forward and then run over this foot in the direction of the throw and land on the right foot, at the same time producing a rotation in order to land in the throwing position.



### INITIAL PIVOTING MOVEMENT

To learn the initial pivoting movement, face the rear, swing the discus to the rear and then rotate both feet towards the left, carrying the knees in the same direction.



## **ARM BEHIND BACK**

To develop fast leg movement across the circle, hold the throwing arm tightly against the back and the left arm relaxed across the chest. Take up position in the back of the circle and execute the movement from the initial turn to the power position maintaining the chin-knee-toe position.

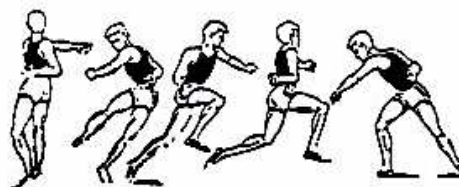

### **3. TRAINING**

During the period of training, the conditioning philosophy will be as follows:

- 3.1. Use an over distance approach.
- 3.2. First quantity, then quality.
- 3.3. Build a foundation of endurance and then develop speed gradually. This will prevent injury.
- 3.4. For the first month of training you will do no speed work and you will not time anything.
- 3.5. You will develop speed by doing a great deal of short, fast work and by improving your sprinting form.
- 3.6. The test distance for endurance will be 300m, and test distance for speed will be 30-50 m. A jumper will only be successful when both tests are done well.
- 3.7. As the season progresses, you will do less work but faster work.
- 3.8. Workouts will generally be a hard day followed by an easy day, with a lightening up of work two days before competition or time trail.
- 3.9. Your schedule is flexible. You may change the daily routine because of weather, body condition, or emotional outlook.
- 3.10. You should completely recover from one workout to the next. If you are not completely recovered, do less work, or rest.
- 3.11. You should never train when you are ill nor have an injury.
- 3.12. If your training schedule is limited, you may telescope this schedule into two-week periods instead of month periods.
- 3.13. Your workouts must be fun or rewarding, preferably both.

### **4. TRAINING SESSIONS**

- 4.1. All training sessions should always start of with warm-up session and stretching exercises.
- 4.2. After all training sessions a cool down and stretching session should follow.
- 4.3. Refer to the chapter on mobility for event specific warm –up and stretching exercises.

### **5. TYPES OF TRAINING**

#### **5.1. GENERAL CONDITIONING**

The need for endurance training for the thrower, such as jogging sessions, is very small. However a change of environment is sometimes needed, and circuit training in a gymnasium, a game of soccer or volleyball can come in handy.

#### **5.2. TECHNIQUE**

Technique exercises must be done on a regular basis. A high school athlete for example should throw at least 75 - 100 technique specific throws per week during the preparation phase and at least 40 full throws. At least 75 - 100 full throws should be executed per week during the high intensity phase.

#### **5.3. MOBILITY**

Strength training tends to reduce mobility especially in the ankle, hip and shoulder joints as well as the spine. This will drastically reduce the capacity to perform, and increase the injury risk. Intensive stretching exercises must be done with every technique session and must be event specific.

#### **5.4. STRENGTH ENDURANCE**

Strength endurance and muscle endurance are not taxed during competition but is necessary to develop to be able to cope with high quality output during long periods of training. It is also valuable

when mental endurance is needed during concentration at an intense level over a long period of time.

Using medicine ball exercises, or weight training at low intensity e.g. 75%, 10 - 20 repetitions and 3 - 5 sets can develop it.

### 5.5. MAXIMUM STRENGTH

Maximum strength is not valuable during the execution of the throw because of the slow muscle contraction, which develop because of maximum strength exercises. However, it provides the foundation upon which all other strength development is based e.g. specific strength, elastic strength and static strength.

Maximum strength can be developed with 80 - 100% weight lifting with 1 - 5 repetitions and 5 - 8 sets.

### 5.6. STATIC STRENGTH

Static strength is used during the blocking of the left side of the body, while the right side of the body delivers the implement. It is developed mainly during weight lifting sessions at 100% intensity with 1 - 3 repetitions and 1 - 3 sets.

### 5.7. SPECIFIC STRENGTH

Specific strength is developed when throwing with implements slightly heavier than competition implements, or with medicine balls.

### 5.8. ELASTIC STRENGTH

Elastic strength is developed during exercises such as jumping, bounding, and hopping and plays an important roll in the delivery speed of the implement.

### 5.9. SPEED

General speed can be developed by means of:

- 30 - 50 m sprints,
- elastic strength exercises
- and explosive use of weight lifting.

### 5.10. SPECIFIC SPEED

For specific speed the athlete can use under-weight implements e.g. a shot with a hole drilled through. The lighter implement (not more than 15% lighter) will give the athlete the experience of throwing distances to which he aspires. To light implements will cause elbow injuries and destroy his timing for the event.

The exercises above are combined in a long term training program that would look more or less as follows:

THROWS LONG TERM PLAN	PHASE					
	Conditioning		Preparation		Competition	
	1	2	1	2	1	2
Training Methods						
General Conditioning	30%	25%	20%	15%	10%	5%
Technique + Mobility	20%	20%	25%	25%	25%	30%
Strength Endurance + Maximum Strength	30%	25%	20%	15%	10%	5%
Specific, Elastic And Static Strength	10%	15%	15%	25%	25%	20%
Speed + Competition	5%	10%	10%	10%	15%	20%
Active Rest	5%	5%	10%	10%	15%	20%

## 6. A TRAINING PROGRAM FOR THE THROWER

- If your training schedule is limited, you may telescope this one month cycles into two week cycles.

- Phase 1 of each sub-section of the program is used as a conditioning period for the new exercises.
- During phase 2 the intensity of the training is gradually increased.
- Two examples of a 14-day training program in all the throwing disciplines are given. One in the pre-season and one in the peak season.

CONDITIONING PHASE	MONTH													
CONDITIONING	M	T	W	T	F	S	S	M	T	W	T	F	S	S
General conditioning e.g. circuit training, volley ball		#		#					#		#			
Technique throws concentrating on specifics	#		#					#		#				
Full throw														
Mobility - event specific	#		#					#		#				
Endurance Strength		#		#					#		#			
Maximum Strength	#		#					#		#				
Static Strength														
Specific Strength														
Elastic Strength														
Speed														
Competition														
Rest					#	#	#					#	#	#

PREPARATION PHASE	MONTH													
CONDITIONING	M	T	W	T	F	S	S	M	T	W	T	F	S	S
General conditioning e.g. circuit training, volley ball				#							#			
Technique throws concentrating on specifics		#		#					#		#			
Full throw	#		#					#		#				
Mobility - event specific	#	#	#	#				#	#	#	#			
Endurance Strength		#		#					#		#			
Maximum Strength	#		#					#		#				
Static Strength														
Specific Strength			#							#				
Elastic Strength														
Speed	#							#						
Competition						#							#	
Rest					#	#	#					#	#	#

COMPETITION PHASE	MONTH													
CONDITIONING	M	T	W	T	F	S	S	M	T	W	T	F	S	S
General conditioning e.g. circuit training, volley ball														
Technique throws concentrating on specifics		#		#					#		#			
Full throw	#		#		#			#		#		#		
Mobility - event specific	#	#	#	#	#			#	#	#	#	#		
Endurance Strength														
Maximum Strength														
Static Strength	#		#					#		#				
Specific Strength		#		#					#		#			
Elastic Strength	#		#					#		#				
Speed	#		#					#		#				
Competition						#							#	
Rest				#	#	#	#				#	#	#	#

## 7. RULES

### 7.1. IMPLEMENT

The body of the discus is made of wood, or other suitable material, with a metal rim, the edge of which is circular. Each side of the discus must be identical and made without indentations, projections or sharp edges.

The sides must taper in a straight line from the beginning of the curve of the rim to a circle of a radius of 25 mm from the centre of the discus.



The senior men's discus weighs 2 kg and has a diameter of 219 to 221 mm; the woman's weighs 1 kg and has a diameter of 180 mm to 182 mm.

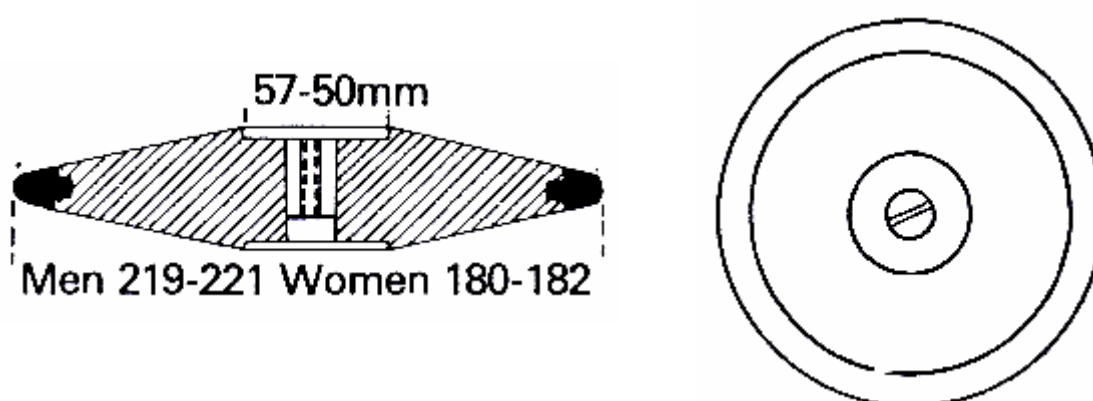

## 7.2. GENERAL RULES

The rules permit touching the face or inner part of the iron ring surrounding the circle, but prohibit stepping on or touching with any part of the body the top edge, or the ground outside, once the throw has begun.

The thrower may not leave the circle before the implement has fallen to the ground, and then his first contact with the metal rim, or the ground outside, must be behind the extension lines at each side of the circle. The time limit of competition of a throw is 1½ minutes.

If there are eight or less competitors, each one should have six attempts. If there are more than eight competitors, each has three attempts and the best eight another three attempts.

## 7.3. THROWING SECTOR

The throwing sector is limited by the inner edges of lines which form an angle of 40° at the centre of the circle

## BIBLIOGRAPHY

1. ASA Domestic Rule Book, Athletics South Africa, Athletics House, P O Box 2712, Houghton, 2041
2. Basic Coaching Manual - I.A.A.F., 3 Hans Crescent, Knightsbridge, London SW1X, England.
3. But First - B.A.F. 225A Bristol Rd, Edgbaston, Birmingham B5 7UB.
4. Discus throwing, Max Jones, - B.A.F. 225A Bristol Rd, Edgbaston, Birmingham B5 7UB.
5. IAAF Rule Book, IAAF 17,rue Princesse Florestine, B.P. 459, MC 98007, Monaco Cedex
6. Techniques of Athletics and Teaching Progressions - I.A.A.F., 3 Hans Crescent, Knightsbridge, London SW1X, England.